

Ag Leader[®]

PRODUCTS & SERVICES



WWW.AGLEADER.COM

PLANT PG. 13

APPLY PG. 19

STEER PG. 7

HARVEST PG. 23

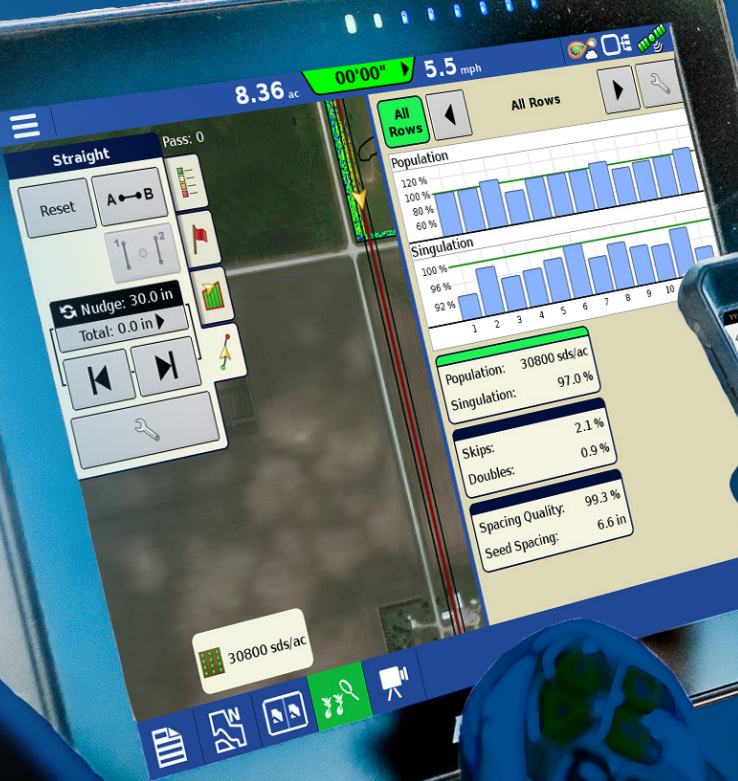

TILE PG. 25



MANAGE PG. 3 & 27



**YOUR OPERATION, IN EVERY SEASON:
CONNECTED.**

THE POWERFUL DUO



Connect Your Operation

AgFiniti puts real-time and historical information right at your fingertips whether in the cab, office, or anywhere in between. Connect all your machines, displays, and devices with the latest information, including location, speed, yield, moisture, population, rate, container level and more.

Gain Real-Time Insights

Easily get all the insights you need to make informed decisions on the spot. No processing or wait time, maps are instantly available to take with you from the cab.

Generate Quick Prescriptions

Quickly and easily generate prescriptions right from the cab or wherever you are.

Additional Features

- ◀ Free Apple and Android app.
- ◀ Maps are available immediately and sync across all connected devices to InCommand displays, SMS Software or other cloud platforms.
- ◀ Easily share files or print maps and reports.
- ◀ Quickly query through multiple layers.
- ◀ Create field notes with pictures.
- ◀ Compare reports of yield by hybrid, population and soil type.

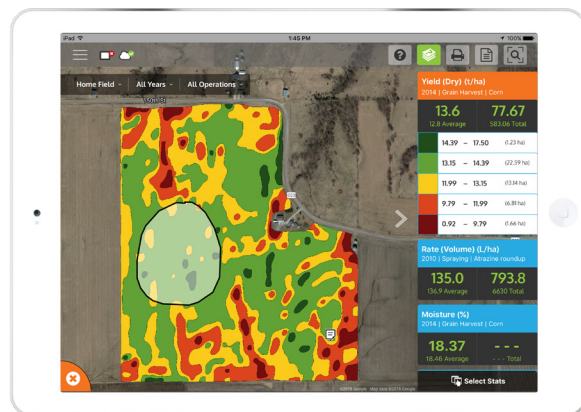

InCommand®

View Two Screens at Once

View more with one display!

InCommand's split screen feature allows users to view historic maps, or detailed information at the same time as the map screen, giving the most visibility for decision making on the go.

ISOBUS Compatibility

InCommand displays are fully ISOBUS compatible and now include the latest V3 Task Controller capabilities which support up to 144 sections on 3rd party ECUs. This makes the InCommand displays even more versatile than ever before!



Sync All Your Displays and Devices

When connected to AgFiniti, all your displays are synced and mirror images of each other. No need to manually transfer configurations, guidance lines and autoswath maps. It's available on every display. Maps are also synced to connected tablets and phones for a fully-connected operation.

Additional Features:

- ◀ Year-round functionality.
- ◀ Tablet-like interaction.
- ◀ Row-Level Detail.
- ◀ Sync live maps between displays and information to all connected devices through AgFiniti.
- ◀ Built-in NTRIP for RTK correction.



See display comparison chart for complete list of features.

CHANGE THE WAY YOU FARM

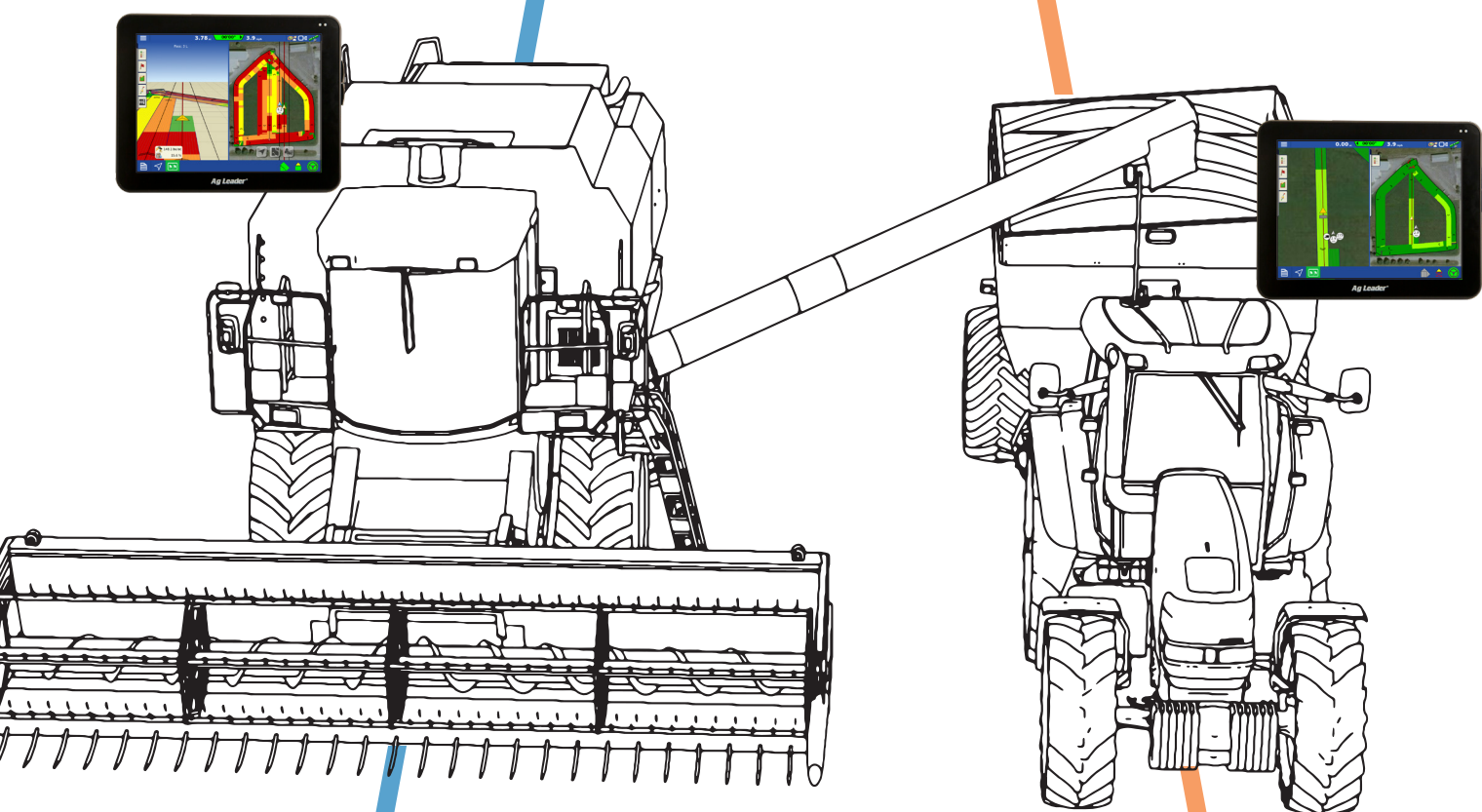

COMING SOON!

CartACE simplifies the grain cart operator's job by sharing a live map of the combine's progress and location through InCommand displays, telling the operator when and where to be. The InCommand display in the grain cart generates a guidance line alongside the combine and the operator engages autosteer for easier, less stressful unloading on-the-go.

DISPLAY FEATURE COMPARISON

InCommand 1200



InCommand 800



Compass



DISPLAY FEATURES

Display Size	30.5 cm	21 cm	17.5 cm
Swipe Gesture	✓	✓	
Split Screen	✓		
Headlands	✓	✓	✓
Multiple Product Control	Up to 8	Up to 3	
Camera Support	4	4	
AgFiniti	✓	✓	
DisplayCast	✓	✓	
Prescription Scaling	✓	✓	
Remote Viewing	✓	✓	

GUIDANCE & STEERING

Lightbar Guidance	✓	✓	✓
Mechanical Assisted Steering	✓	✓	✓
Hydraulic Automated Steering	✓	✓	✓
GLIDE, SBAS (WAAS/EGNOS), TerraStar, RTK	✓	✓	✓
SmartPath	✓	✓	✓
Tramlines	✓	✓	✓
StableLoc	✓	✓	✓

PLANTING/SEEDING

Hybrid/Variety Logging	✓	✓	
Variable Rate Planting	✓	✓	
Planter Section Control (AutoSwath)	36 sections	36 sections	
Split-Planter Logging	✓	✓	
Planter Population Monitoring	✓		
Advanced Seed Monitoring	✓		
Hydraulic Down Force Logging	✓		
Row-by-Row Planter Performance	✓		
SureDrive Electric Drive Control	✓		

APPLICATION CONTROL

Liquid Product Application Control	✓	✓	
Liquid Section Control (AutoSwath)	36 sections	36 sections	
Variable Rate Application	✓	✓	
Chemical Injection	✓	✓	
Boom Height Control	✓	✓	
SmartReport	✓		
AutoSwath Based on Previously Applied Maps	✓	✓	
Container Sequencing	✓		
Dry Product Application Control	✓	✓	
Closed Loop Spinner Speed Control	✓	✓	
Strip-Till	✓	✓	
Air Seeder Support	✓	✓	
OptRx Crop Sensors	✓		
ISOXML Data Export	✓	✓	

YIELD MONITORING

Grain Harvest	✓	✓	
Harvest Variety Tracking	✓		
Load Variety Maps	✓		

WATER MANAGEMENT

Topography Mapping	✓	✓	
Survey Collection	✓	✓	
Intellislope Plow Control	✓		

ISOBUS

Universal Terminal Support	✓	✓	✓
Task Controller	✓	✓	

WORK MORE, STRESS LESS



The touchscreen Compass display is an entry-level display for guidance, assisted steering, automated steering and Universal Terminal functionality. Compass is designed for easy setup and operation.

Compass Display

- ◀ Compact design with built-in lightbar.
- ◀ Built-in manual guidance.
- ◀ Compatibility with Virtual Terminal Standard.
- ◀ Fullscreen mapping.
- ◀ Multiple language options.
- ◀ Use OnTrac3 assisted steering or SteerCommand with GPS 7500 integrated steering system for high-end guidance.

GPS 6000

- ◀ Entry-level option for growers seeking a cost-effective receiver.
- ◀ Single-frequency receiver designed for general mapping and AutoSwath functions.
- ◀ Differential corrections include GLIDE, WAAS/EGNOS.
- ◀ GLONASS standard.
- ◀ Outputs radar speed for other devices in cab.
- ◀ LED diagnostics for system monitoring.

ASSISTED STEERING FOR IMPROVED ACCURACY

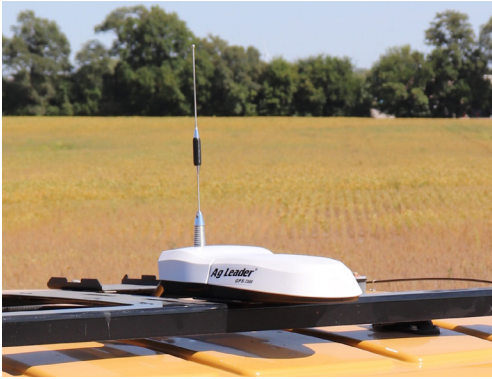

GPS 7500

- ◀ Up to 2.5cm accuracy with options of RTK, TerraStar-X, TerraStar-C Pro, TerraStar-L, WAAS/EGNOS, GLIDE.
- ◀ Rover radio 400 or 900 or cellular options.
- ◀ GLONASS standard.
- ◀ Outputs radar speed for other devices in cab.
- ◀ LED diagnostics for system monitoring.



GPS 7500 Base Station

- ◀ GPS 7500 can be converted to a dual-frequency RTK base station.
- ◀ Radio 400 and 900 options.
- ◀ Access to multiple GNSS signals, including GLONASS.
- ◀ Wi-Fi capability for setup by phone or tablet.



OnTrac3 Assisted Steering

OnTrac3 improves pass-to-pass accuracy with simplified steering for any modern tractor, harvester or application vehicle.

- ◀ No need to hook into hydraulics or remove the steering wheel to install.
- ◀ “Lock-n’-Roll” simplifies installation and makes for easy vehicle transfer.
- ◀ Quiet Operation.
- ◀ Clutchless, brushless design allows more torque for faster steering.
- ◀ Compatible with GPS 7500 or GPS 6000 receivers.

ELITE STEERING PERFORMANCE



InCommand: Can share guidance lines and more using AgFiniti with DisplayCast.

For growers seeking an integrated steering experience, SteerCommand offers best-in-class integrated steering performance when paired with GPS 7500 for repeatable, precision steering via various correction sources.

SteerCommand Automated Steering



SteerCommand Automated Steering

The controller connects directly to vehicle CAN bus, steer-by-wire or hydraulic valve, and offers leading precision steering performance when paired with GPS 7500.

High Accuracy

GPS 7500 with SteerCommand supports GLIDE, WAAS/EGNOS, TerraStar and RTK. Access NTRIP and other RTK networks for repeatable sub 2.5cm accuracy using the GPS 7500 combined with the RTK Relay. SteerCommand also features nine-axis terrain compensation, an internal compass, and easy vehicle installation and transfer.

UNMATCHED STEERING ACCURACY

SteerCommand with DualTrac

SteerCommand with DualTrac is a high-accuracy steering solution for operations requiring ultra-low speed. Operations such as planting or harvesting bedded crops, installing drip tape or planting and harvesting specialty crops can benefit from DualTrac's precise steering.



Ultra-Slow Speed

SteerCommand with DualTrac performs at speeds as slow as 0.08 km/h.



Dual Antenna

Dual GNSS antennas are mounted on one bracket for easy installation and transfer.



Reliable Heading

The system maintains stable heading even when not moving.



Sub 2.5cm Accuracy

Access RTK via Relay or Cellular NTRIP.



VERSATILE GUIDANCE



New! Access Paths: Users can specify a repeating space or break between guidance paths for any field obstruction such as roads or irrigation ditches.

From entry level, up to the most accurate steering system on the market, Ag Leader offers a solution for every operation.

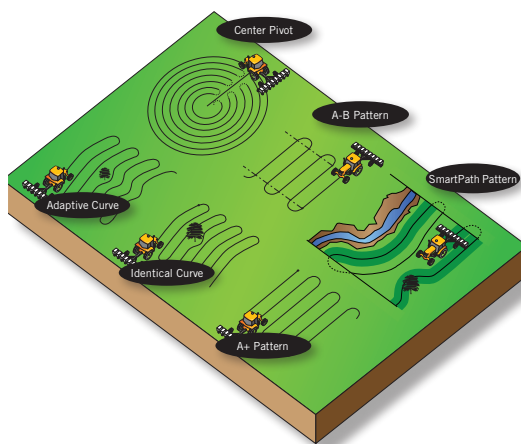

SmartPath Pattern

Drive one pass through the field to establish a custom guidance pattern based on your initial pass.

Using Pattern Groups

Easily group all patterns in a field with the ability to cycle through and select a pattern with a single button press.

GUIDANCE SOLUTIONS FOR EVERY OPERATION

Which level of accuracy do you need?

TerraStar-X, RTK

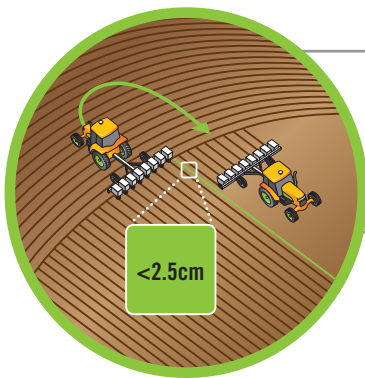

NEW! TerraStar-X

Regional subscription-based correction source with less than 1 minute convergence time and sub-2.5cm pass-to-pass accuracy.

*Available in select markets.

NTRIP RTK

InCommand displays have built-in NTRIP compatibility that networks to RTK corrections and AgFiniti, through a single cellular data plan.

TerraStar-C Pro

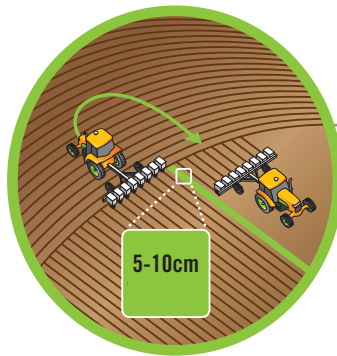

TerraStar-C Pro

Multi-constellation support for great positioning accuracy, availability and reliability.

TerraStar-L, WAAS/EGNOS

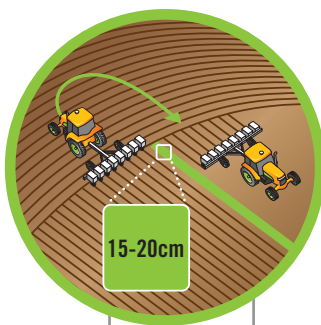

GLIDE

Improved accuracy without subscription-based differential correction.

StableLoc

Maintains accurate steering even when the correction signal is temporarily lost by transitioning to next available source. Available for GPS 6000 and GPS 7500.

GPS SYSTEM COMPARISON	GPS 7500	GPS 6000
APPLICATIONS		
Guidance	✓	✓
Tillage	✓	✓
Harvesting	✓	✓
Field Preparation	✓	✓
Mapping (Point, Line, Area)	✓	✓
Variable Rate Controllers	✓	✓
Spreading	✓	✓
Spraying	✓	✓
Seeding	✓	✓
Log Hybrid/Variety	✓	✓
Assisted Steering	✓	✓
Automated/Hydraulic Steering	✓	
Strip-Tilling	✓	
Intellislope (Tile Plow)	✓	
GPS DIFFERENTIAL CORRECTION		
RTK	✓	
TerraStar-X	✓	
TerraStar-C Pro	✓	
TerraStar-L	✓	
WAAS/EGNOS	✓	✓
GLIDE	✓	✓

POWERFUL PLANTING TOOLS



InCommand: Use the Seed Row unlock for the InCommand 1200 to select your rate by row.

Each planting season you get one chance to get it just right. Making sure your planter is performing optimally and each seed is being placed at the right depth, at the right spacing and at the right population is critical. Best of all, you can improve the planter you already know and love.

Connect All Your Displays

DisplayCast connects all your InCommand displays to seamlessly share guidance lines, as-planted maps for AutoSwath, configurations and more across your operation. No longer worry about needing to move variety maps from the planter to the combine.



SEE YOUR PLANTER'S PERFORMANCE LIKE NEVER BEFORE

Planter Performance has Been a Guessing Game Until Now

At the row level, planter performance issues, like skips and doubles, are quickly identified so operators can immediately take action and avoid costly mistakes. That's not it! See multiple screens at once with InCommand's unique split-screen feature. Don't wait until harvest to evaluate planter performance - get InCommand!

Unmatched Planting Visibility

Get row-level mapping for spacing, skips, doubles, downforce applied, and more.

Integrated Machine Guidance

InCommand features a built-in lightbar and autosteer capabilities.

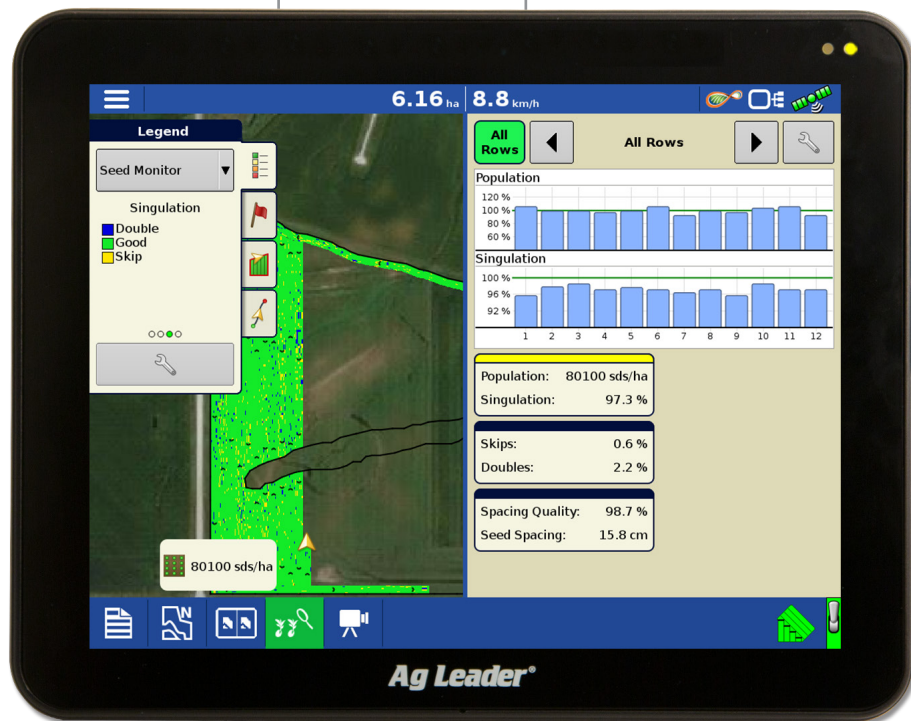

Satellite Imagery

Maximize your visibility in the field with satellite imagery.

Split-Screen Display

View two screens at once with the split screen feature. Choose between in-depth analysis screen, or historical maps and data, and more!

SURE AT ANY SPEED



InCommand: Know your planter is performing. System alarms will alert users of potential planter issues and how to fix them.

There are years that narrow planting windows force farmers to decide whether they plant faster and sacrifice seed placement or to drag out the season but place seeds optimally. We say “why choose?” with the introduction of SureSpeed.

Perfect Spacing

SureSpeed accurately places seed at 19 km/h, but also at speeds much slower. Perfect planting is a priority, speed is an added bonus.

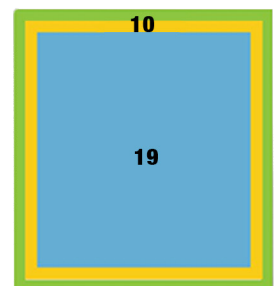
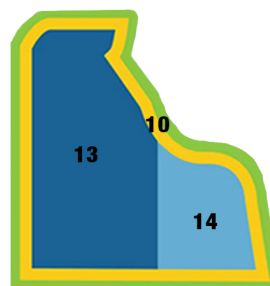
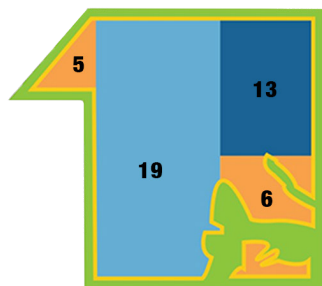

NEW! **Ag Leader[®] SureSpeed**

FOR ACCURACY AND EFFICIENCY



Aftermarket Solution

With solutions for various makes and models of box hopper and bulk fill planters, the system was designed to give your planter high accuracy at high speeds.

Singulation & Spacing

Unique meter design and controlled transfer of seeds from meter to delivery device maximizes singulation and ensures perfect spacing at speeds up to 19 km/h.

Performance

The flighted delivery belt has the lowest release point in the industry for consistent spacing at any speed.

Maintenance

Low maintenance system. No tools required.



Pair with SureForce

SureSpeed paired with SureForce maintains consistent ground contact and smooth row unit ride with increasing speed in varying conditions.



Ease of Use

Controlled by the industry-leading, user-friendly InCommand 1200 display.

YOUR PLANTER REIMAGINED



AgFiniti: Know exactly how much down force was applied, row by row, across your whole planting operation. Take this information with you to verify stand health and variety performance.

SeedCommand products come together to bring unmatched planter technology to your farm. Fields planted at consistent depths and spacing make for uniform emergence, picket fence stands and ultimately more yield come harvest. So what are you waiting for?

SureForce

Dual-Acting Control

Hydraulic Down Force applies up to 295kg additional weight to the row unit to overcome the heaviest compaction. Integrated Hydraulic Uplift removes weight from the row unit to maintain consistent planting depth regardless of soil conditions.

View Down Force Maps On the Go

View gauge wheel load and down force applied maps on your InCommand display, or with AgFiniti.

Individual Row Control

Monitor, record and control the down pressure needs of each individual row to allow for consistent planting depths across various topography and soil conditions.

No Margins, No Guessing

Let InCommand and SureForce do the work for you! Simple user preference settings maintain your gauge wheel contact and there's no guessing with InCommand's high-resolution row-by-row down force map.

POWERFUL METER CONTROL

SureDrive Electric Drives

Powerful Meter Control

Individual row section control to quickly vary the speed for population rate changes and turn compensation.

Versatile to Work with Your Meter

The electric drive motor isn't tied to a specific brand or type of seed meter - including hard-pulling finger meters.

Turn Compensation

SureDrive automatically adjusts meter speed on each row to keep a consistent population around turns, contours and terraces.

Maintenance Free

SureDrive's robust, sealed construction is maintenance free for durability and reliability.

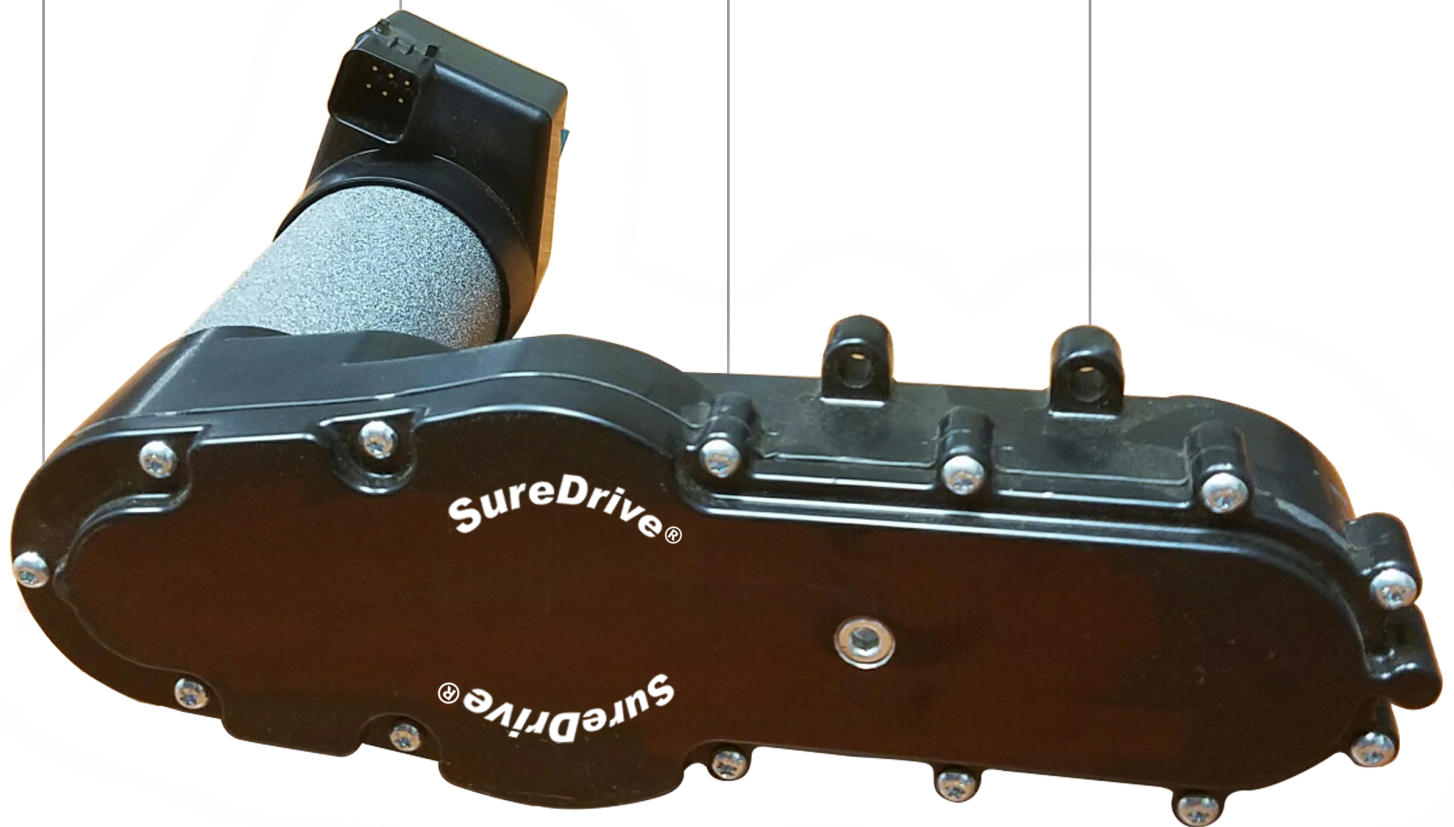
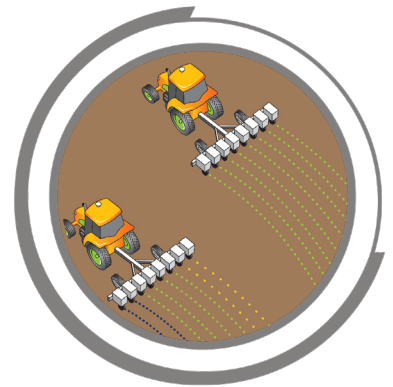

APPLICATION CONTROL THAT MEETS TODAY'S CHALLENGES



AgFiniti: Keep track of your sprayer from anywhere, knowing when it needs to be refilled and ensuring the right product and rate is being applied to the appropriate crops.

Product application is becoming more challenging every year. Many chemicals require a specific droplet size to be effective and the implications of misapplication are becoming more severe - from developing herbicide resistance to crop damage.

Liquid and Granular Application Control

Your resources are valuable and important. Whether you have an NH3 toolbar, Liquid N side-dress unit sprayer, spreader or fertiliser pump on your planter, DirectCommand will transform your application process, providing maximum ROI.



PRECISE CONTROL FOR ANY PRODUCT



Avoid Spray Drift

DirectCommand takes drift control one step further with real-time droplet size monitoring in an easy to use interface. Apply with accuracy, efficiency and safety.

Proper Plant Coverage

DirectCommand promotes proper coverage through the pressure fallback feature, allowing it to spray more accurately in low flow rate scenarios. Achieve proper plant coverage at all flow rates, period.



Controller Compatibility

Compatible with standards for Universal Terminal and Task Controller, DirectCommand works with Ag Leader and other brands of UT compatible displays.

Chemical Effectiveness

Increase agro-chemical effectiveness by monitoring droplet size to ensure application products are applied at the droplet size recommended on the label. DirectCommand's droplet size monitoring has settings from ultra-course to extremely fine so operators can dial in application to their nozzle's ideal range.

SEE YOUR CROPS IN A NEW LIGHT



AgFiniti: OptRx can also be used as a scouting tool to gather crop health information with every in-season field pass.

Use OptRx to easily capture more ROI during a side-dress or top-dress application. OptRx places more nitrogen where crops will respond to additional fertility while applying less where it will not.

How it works:

OptRx Crop Sensors make variable rate application simple by measuring your crop's health as you drive through the field and applying the right prescription instantaneously.

Flexible Application

Use the Rate Table to assign your preferred rates to crop health readings. OptRx is a valuable tool for any crop and will generate an ROI by variable-rate application of nearly any product.



DOCUMENTATION SIMPLIFIED

Ag Leader Technology
8 Douglas Drive
Mason Lakes South Australia 5095 Australia
(088)-250-9800

Ag Leader Technology
APPLICATION REPORT

Grower Smiths PO Box 1234 Moree New South Wales 2400 Australia	Field Field: A Farm: Big County: Description: Township: Range: Section:				
Equipment Configuration Vehicle: Goldacres G6 Implement: Goldacres G6 Boom Height:	Application Timing: Post Harvest Placement: Nozzle PN: 02 Boom Pressure:	Application Date/Time Start Time: 05/12/2017 6:15 PM End Time: 05/12/2017 6:49 PM			
Product: Burndown Applied Area: 48.21 ha					
<p>Total Field Area: 45.53 ha</p>					
Crop Crop: Growth Stage:	Restrictions Crop Rotation Restrictions: Yes Restricted Entry Interval (REI): 24 h	Target Pests Milk thistle Turnip			
Product Summary					
Name	Manufacturer	EPA #	RUP	Amount	Average Rate
Burndown			No	3398.17 L	70.48 L/ha
Water			No	3340.40 L	69.28 L/ha
Glyphosate			No	40.78 L	0.85 L/ha
2-4-D			No	16.99 L	0.35 L/ha
Ary			No	339.82 g	7.05 g/ha
Operator/Supervisor Information					
Operator: Blogs, Joe	License: AL987345	Signature			
Operator:	License:				
Supervisor:	License:				

SmartReport

- Reports provide location, product information, applied totals, field areas, as-applied maps and field boundaries.
- Enter basic information about weather, soil conditions, products used, etc.
- Generate PDF reports automatically when leaving the field that can be saved, emailed or printed.
- Requires no additional software.

Simplify application reporting (both liquid and granular) with detailed SmartReports from your InCommand 1200 display. Satisfy government record keeping by easily sending reports from the display to store and view on any web-enabled mobile device with AgFiniti.

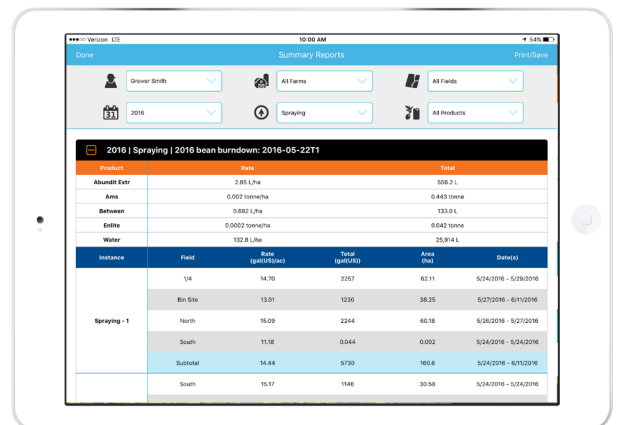
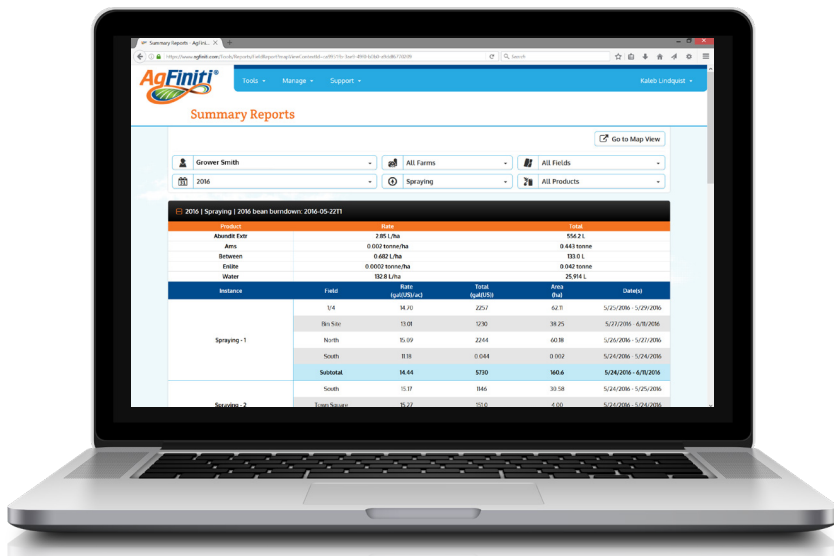

TRUST NOTHING LESS THAN THE BEST



AgFiniti: Take your yield maps with you on the iPad for quick in-season decision making. Email maps and log files from the cab to partners and trusted advisors.

Ag Leader yield monitoring technology started the data revolution with the first on-the-go yield monitor in 1992. Today, trustworthy yield data is crucial for informed management decisions. Don't trust just anyone with this valuable data - trust the yield monitoring experts at Ag Leader.

More Than a Yield Monitor

InCommand and AgFiniti can connect your harvest operation with live stats from your displays and mobile devices. Speed, direction, location, yield, moisture and more shared across all connected devices. This means you can keep track of where the lorry is, easily know the harvester's location, see crop yield/moisture and more. With Ag Leader, information is in YOUR hands.



ACCURATE YIELD DATA HAS NEVER BEEN SO EASY



Increased Visibility

View and mirror up to four cameras in high definition, right from the display for safe transport, smooth grain unloading and more. Even better, utilise the split-screen feature of the InCommand 1200 to see cameras and the map screen at once.



Convenient Harvest Features

- ◀ Improved calibration loads provide accurate data in few steps.
- ◀ Two resettable tonne counters track tonnes without creating new regions.

Opportunities for Profit

Use AgFiniti to scout contributing factors of yield loss. Take yield data anywhere with you on your iPad and even combine multiple displays' yield data to make informed in-season decisions. Then, use AgFiniti to share with cooperators and advisers by effortlessly transferring your maps and data through email or sharing relationships.



DO-IT-YOURSELF TILE INSTALLATION



AgFiniti: See the length of your tile install runs, total tile length installed and field tile installation locations.

Water management on your farm is important, and there are big savings to be had by adopting a DIY approach to tiling. Install your own drainage tile with Intellislope! Intellislope provides easy installation, planning and record keeping, making your job easier.

Promote Root Development

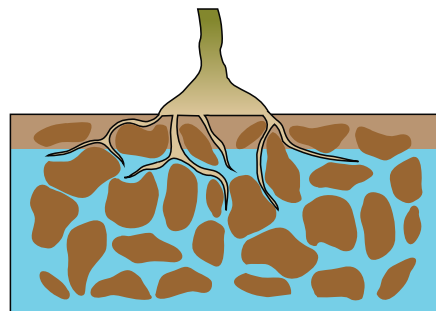
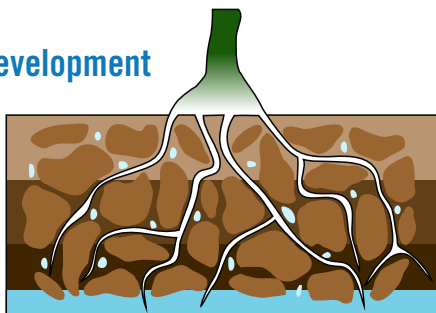

Well-drained soils encourage deeper root development and healthier crops. Saturated soils lead to shallow root growth and poor plant development.

INSTALLING TILE IS EASY AS 1, 2, 3

1 SURVEY

Collect soil profile information (survey) for the area to be tiled before tile installation, or while using the tile plow and RTK GPS. Knowing the soil profile provides elevation information needed for tile placement.

2 PLAN

Enter parameters in the display that ensure tile is placed correctly in order to properly drain soils. Enter these parameters in the field, or utilise the SMS Advanced Water Management Module in the office.

3 INSTALL

Use the plan you created to install your tile. Utilise AutoTile to adjust the plow depth automatically to ensure accurate installation.



SMS Water Management Module

Easily design strategic field tile plans based on precise supporting RTK topography layers. Once the plan is complete, SMS will validate the plan to ensure desired drainage.

- ◀ Easily validate that tile runs are sized appropriately to meet drainage needs and ensure proper tile sizing using the Drainage Coefficient tool.
- ◀ Velocity fail-safe ensures tile is laid on a grade appropriate for the soil texture at the intended depth.
- ◀ Create the best field tile plan by comparing multiple installation plans for cost and drainage efficiency.

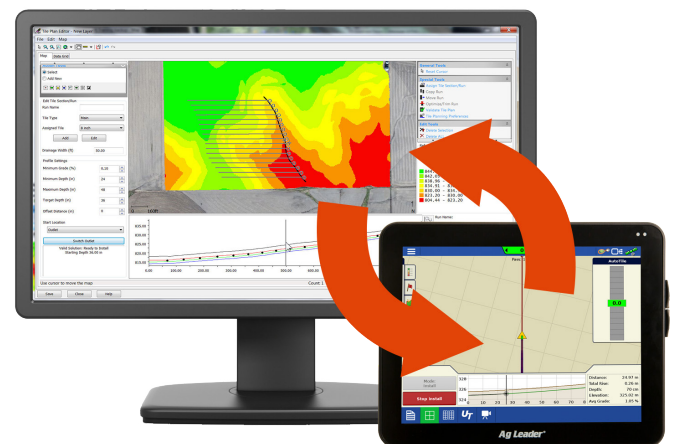

PLAN, MANAGE, PROFIT

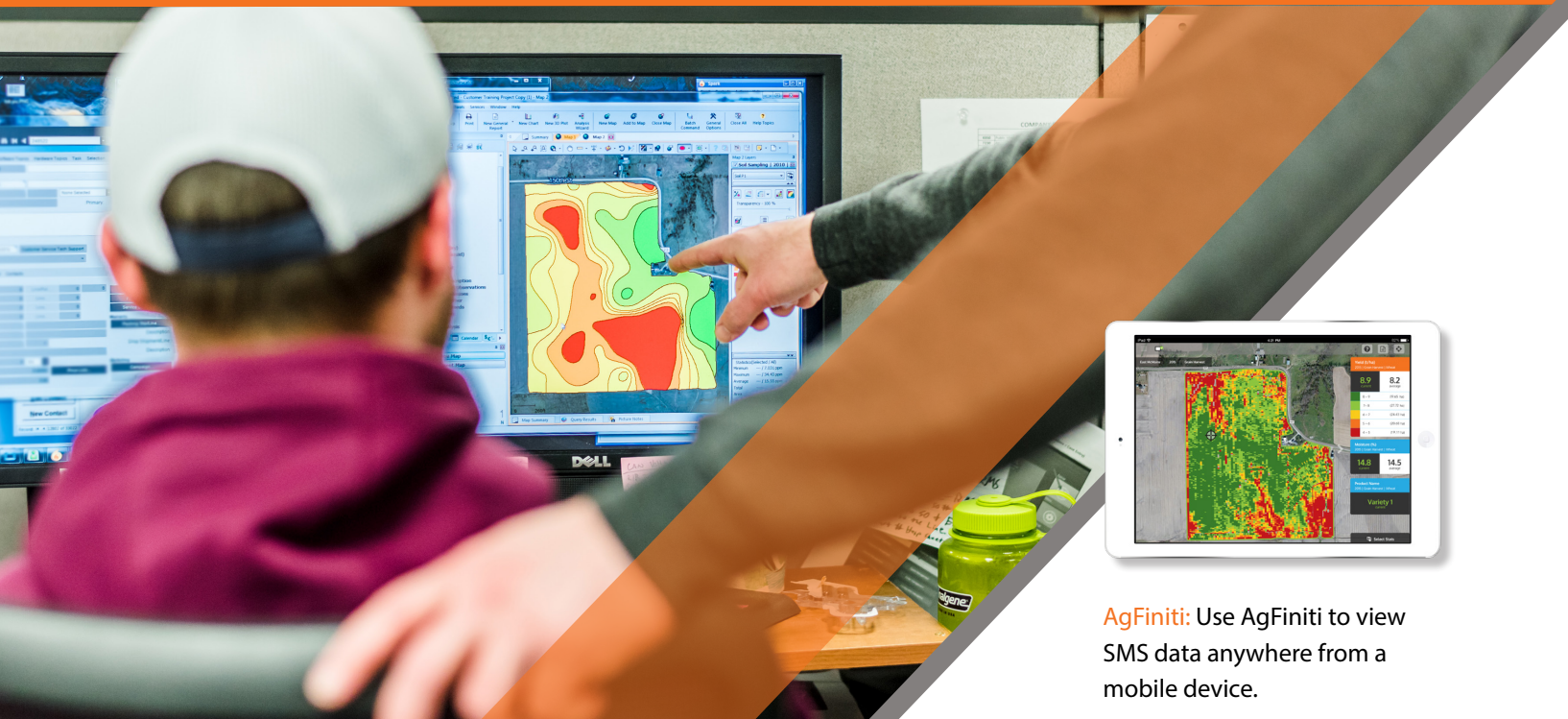

AgFiniti: Use AgFiniti to view SMS data anywhere from a mobile device.

We understand smart management decisions are crucial in farming operations. SMS Software was developed with this in mind, so you can make well-informed decisions based on all your data. No matter the brand of display the data is from, SMS makes data management simple in every season.



Powerful Analysis For All

Precision farming isn't about spending endless hours crunching numbers and analysing data. It's about answering questions that can make you more profitable. That's the simple idea behind Ag Leader's industry-leading SMS Software, an easy-to-use decision-making tool to help you capture the most out of every hectare.

INDUSTRY-BEST SOFTWARE

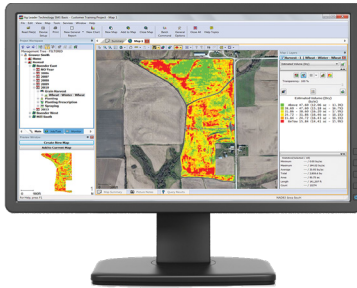

SMS Basic

Use information captured from an operation – planting, application, harvest and more – to turn data into smart management decisions with the powerful SMS Basic desktop software.

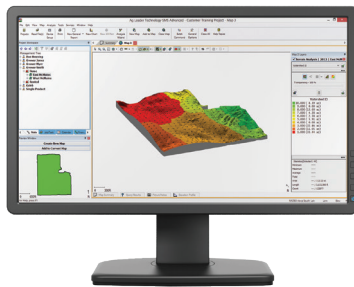

SMS Advanced

Ag Leader's feature-rich SMS Advanced gives growers and trusted advisors data management across many hectares, fields and operations. SMS Advanced carries all of the features of SMS Basic, plus additional tools and features designed for superior analysis and report generation.



SMS Mobile

Collect in-field information such as crop scouting, soil sampling, boundaries and more with SMS Mobile. Once data has been captured, sync with SMS Basic and Advanced for greater data analysis.

SMS Features Comparison	Adv.	Basic
File Processing from Most Displays	✓	✓
Sort Data by Geography	✓	✓
Generate Crop Plans	✓	✓
Create, Manage and Export Guidance Lines	✓	✓
Print Summary Maps, Charts and Reports	✓	✓
Write Simple Prescriptions	✓	✓
Aerial/Road Backgrounds	✓	✓
Query Tools to Analyse Specific Areas	✓	✓
Check for Updates	✓	✓
Soil Survey Import (U.S. ONLY)	✓	✓
Project Management	✓	(limited)
View Map Data in AgFiniti	✓	✓
Financial Entry	✓	✓
Send/Receive Files with AgFiniti*	✓	✓
View Data with AgFiniti Mobile*	✓	✓
Equation Writing	✓	
Calendar View	✓	
3-D Plotting and Terrain Viewing	✓	
Comparison Analysis	✓	
Correlation Analysis	✓	
Terrain Analysis	✓	
NDVI Analysis	✓	
Profit/Loss Mapping	✓	
Cluster Analysis	✓	
Multi-Year Averaging	✓	
Display Elevation Surface Contours	✓	
Multiple Data Storage Locations	✓	
Dataset Playback	✓	
Backup Scheduling	✓	
Booklet Printing**	✓	
Water Management**	✓	
Plot Prescription**	✓	
Field Trials**	✓	

*Requires AgFiniti Essentials License

**Optional Module

A TRADITION OF SERVING FARMERS.

Ag Leader was started by an engineer with a dream of improving the lives of farmers. That dream led him to invent the first commercially successful on-the-go yield monitor. Today, we have that same goal as we bring precision technology to the market, helping farmers plan, plant, apply and harvest more efficiently and accurately.

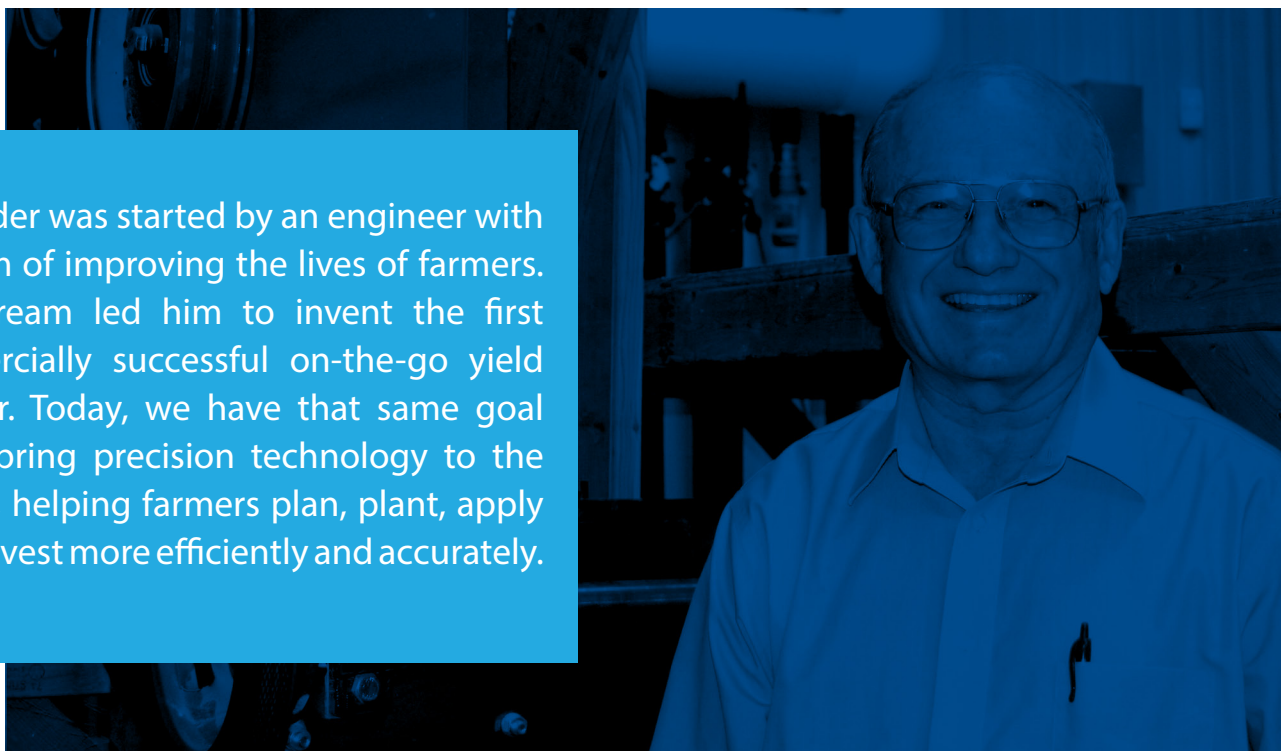



Contact Your Local Precision Expert

Our extensive and dedicated dealer network is the backbone of our company. Visit your local Ag Leader dealer to discover how precision tools from Ag Leader can benefit your operation.

[FIND A DEALER » AGLEADER.COM](https://www.agleader.com)

Ag Leader®

Ag Leader[®] Technology

Ag Leader Technology, Inc. • 2202 S Riverside Dr, Ames, IA 50010 USA • www.agleader.com

EMEA office • Sluisweg 11, 6582 AG Heumen, The Netherlands
www.agleader.com • EMEA@agleader.com



Ag Leader reserves the right to make changes in engineering, design and specifications, and improvements, or discontinue manufacture at any time without notice or obligation. Ag Leader[®], Ag Leader Technology[®], InCommand[®], SureDrive[®], OptRx[®], Intellislope[®], AutoTile[®], AgFiniti[®], SeedCommand[®], DirectCommand[®], SureForce[®], DualTrac[®], SteerCommand[®], StableLoc[®], DisplayCast[®], SmartPath[®] are registered trademarks of Ag Leader Technology Incorporated. Compass[™], AutoSwath[™], SmartReport[™], SMS[™] Software, CartACE[™], SureSpeed[™] are trademarks of Ag Leader Technology Incorporated. Copyright © 2020 Ag Leader Technology Incorporated. All other marks are owned by their respective companies represented herein: Apple[®] iPad[®], Apple Store[®], OnTrac3[™] - Novariant, Inc., TerraStar - NovAtel, Inc.